



IceBank[®]

THERMAL ENERGY STORAGE

DRAWING
Model 1082C4F, U4F
August 2007
CS-76

CALMAC Manufacturing Corp. 3-00 Banta Place Fair Lawn, NJ 07410 Tel (201) 797-1511 www.Calmac.com

NOTE: Model 1082CU4F contains an internal expansion joint required for direct connecting of more than three tanks.

Rigging Loops (2)

Allow 24"
(600 mm)
overhead
clearance
for service.

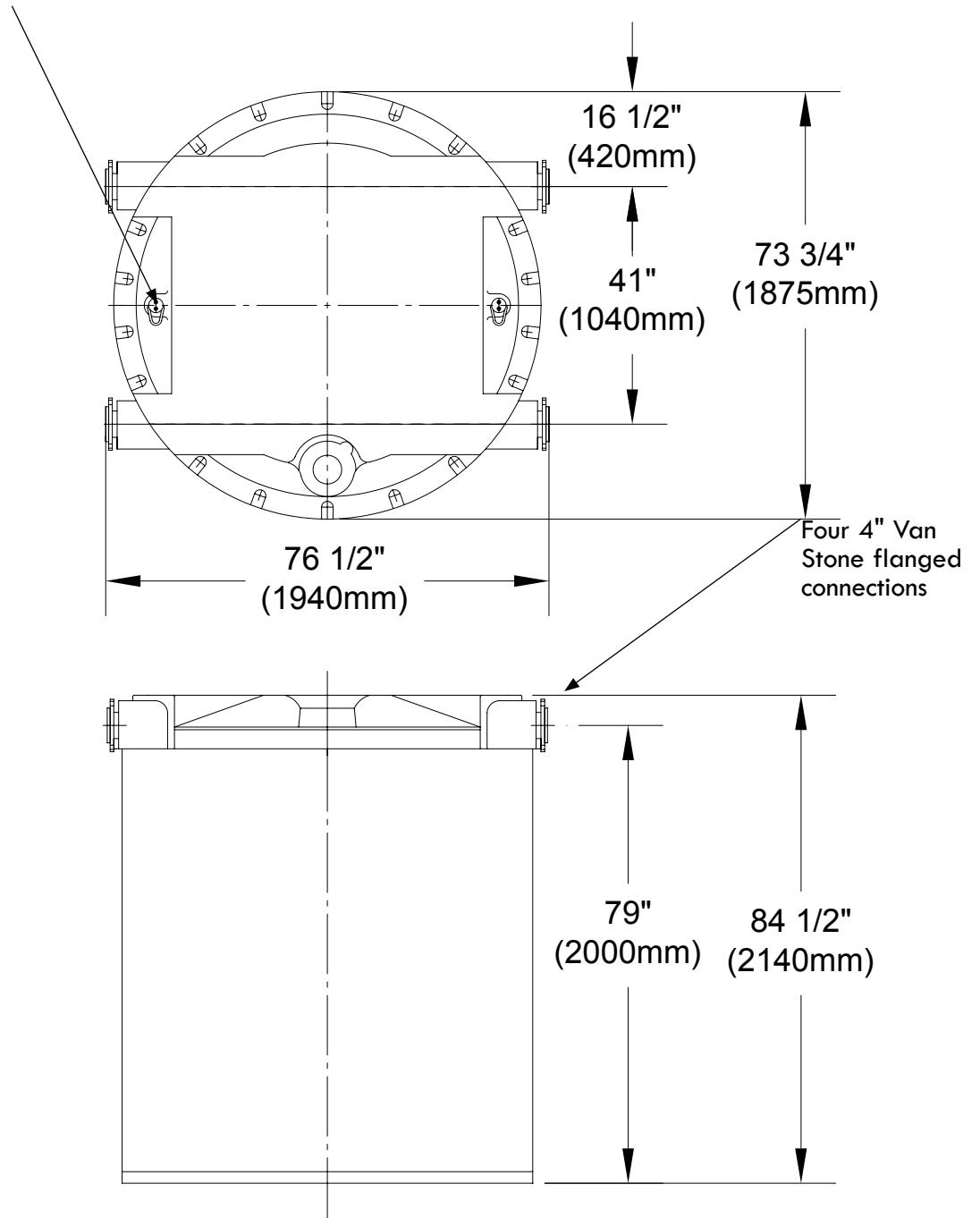

NOTE: Tolerance for all dimensions is $\pm 1/2"$ (12.5 mm)